







Closer

Installation Guide

Instrucciones para el brazo cerrador

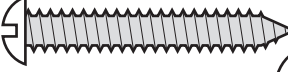
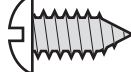
Parts List				Lista de piezas			
Closer Brazo cerrador	Hold Open Washer Arandela para mantener abierto	Door Bracket Soporte de la puerta	Jamb Bracket Soporte de la jamba	#10 x 1-1/2" Screws Tornillos No. 10 x 1-1/2 in (3,8 cm)	#10 x 5/8" Screws Tornillos No. 10 x 5/8 in (1,6 cm)	Long Pin Pasador largo	Short Pin Pasador corto
							

1 Pre-load Closer

Position hold open washer as shown. Inserte la arandela para mantener abierto en su sitio.

Insert a screwdriver into hole in rod, and pull out closer rod 1/4". Utilice un destornillador para sacar la varilla del brazo cerrador 1/4 in (6,4 mm).

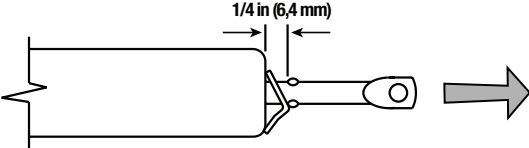

1/4 in (6,4 mm)

2 Install Closer

Position closer so that it does not interfere with top jamb or drip cap. Coloque el brazo de modo que no interfiera con la jamba superior ni con el canal de goteo.

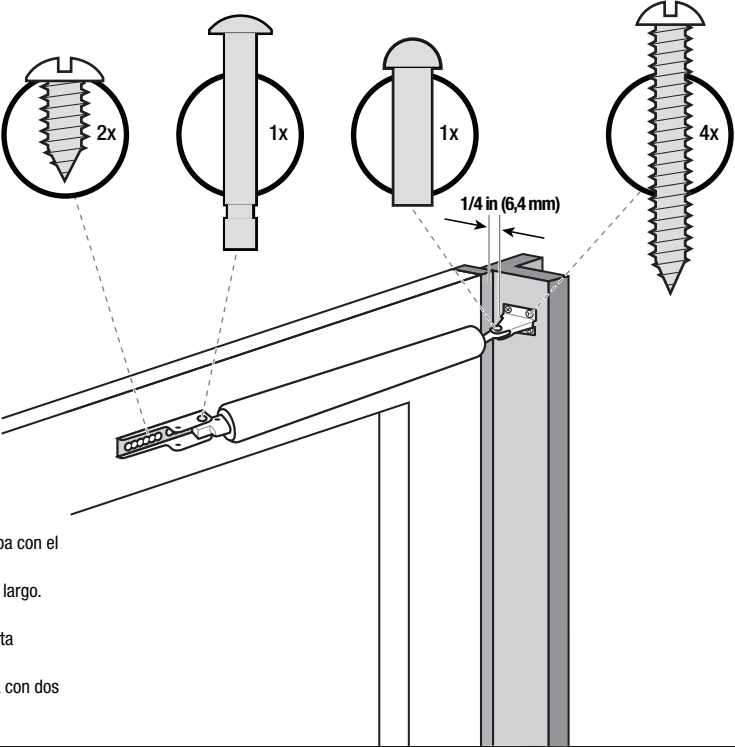

2x

1x

1x

4x

1/4 in (6,4 mm)

INTERIOR

- Drill 1/8" pilot holes in jamb.
- Install screws in jamb.
- Secure closer to jamb bracket with short pin.
- Secure door bracket with long pin.
- Close door.
- Level and drill an 1/8" pilot hole in the middle of each slot (**Do not drill through door**).
- Install door bracket on door with two screws.

- Taladre agujeros guía en la jamba.
- Coloque los tornillos en la jamba.
- Fije el brazo cerrador al soporte de la jamba con el pasador corto.
- Fije el soporte de la puerta con el pasador largo.
- Cierre la puerta.
- Nivele y taladre 2 agujeros guía en la puerta (**No taladre a través de la puerta**).
- Instale el soporte de la puerta en la puerta con dos tornillos.

3 Adjust Closer

Turn the adjusting screw to control the speed of the closer. Gire el tornillo de ajuste para controlar la velocidad del brazo cerrador.

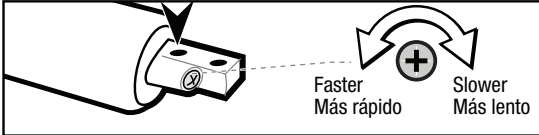

Faster
Más rápido

Slower
Más lento